

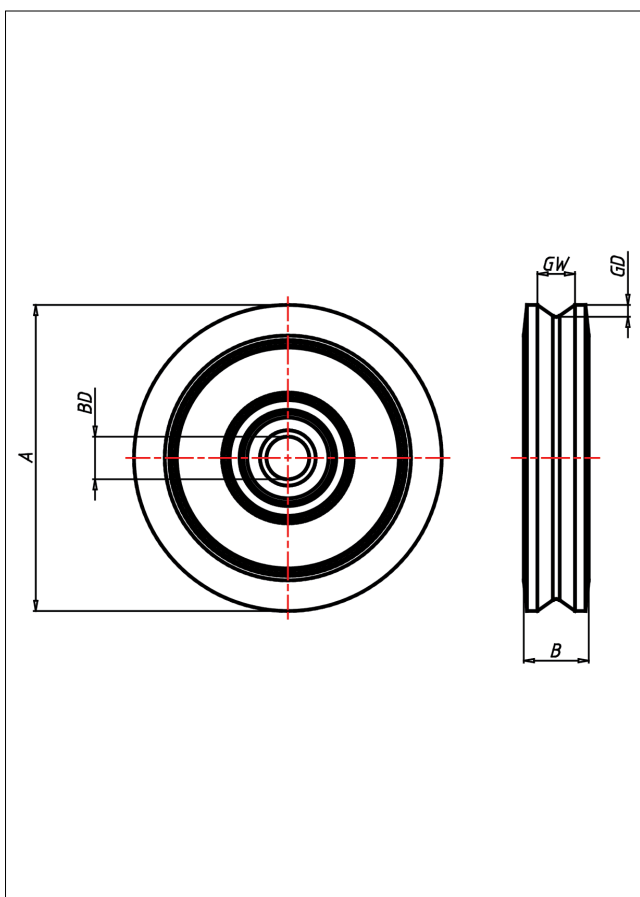

Seilrollen aus Stahl

Seilrolle



Seilrollen Stahl Seilrollen aus Stahl



+40 °C
-15 °C

max.
10000 kg



Seilrolle aus Stahl
abgedichtetes Kugellager

- sehr hohe Tragkraft
- Seilnille voll bearbeitet

Technische Details

ORDERNO (Artikel-nummer)	181/180
WDAB (Rad-Ø A x Breite B / mm)	180x38
LC (Tragkraft / kg)	2000
GD (Nut-tiefe / mm)	7
GW (Nut-breite / mm)	22
HW (Nabellänge / mm)	32
FL (Einbaulänge / mm)	32
WB (Radlager)	Ball bearing
BD (Bohrungsdurchmesser / mm)	25