

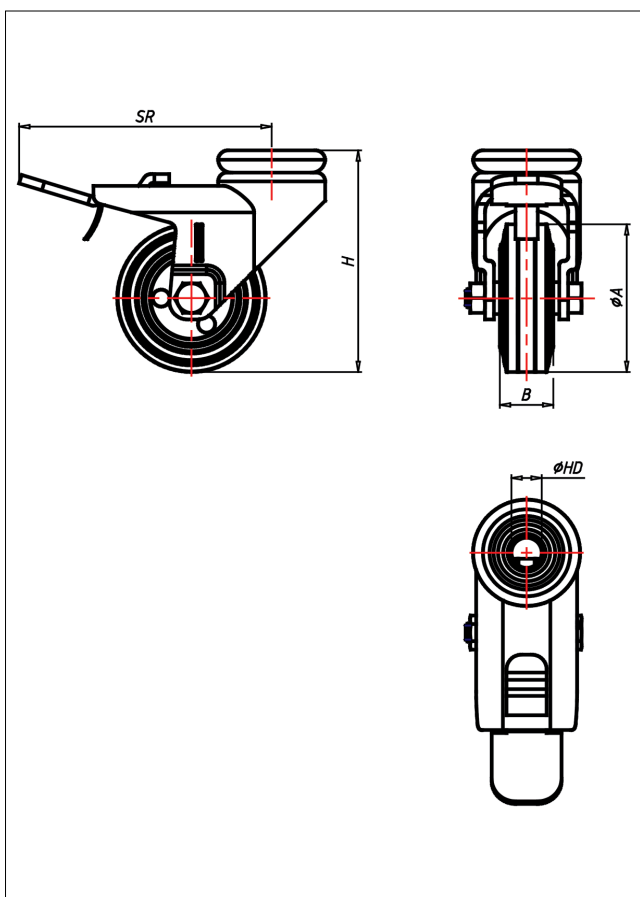

312X RÜ-EL

Lenkrolle mit Totalfeststeller



310XR-EL



+60 °C
-20 °C max. 50 kg

LENKROLLE	LENKROLLE MIT TOTALFESTSTELLER	
<ul style="list-style-type: none"> • elektrisch leitfähig • Widerstand <math>10^4 \Omega</math> • geräuscharmer Lauf • großer Fahrkomfort • beständig gegen verdünnte Säuren <p>Vollgummi oder TPE spritzguss Felge Stahlblech oder Aluminium → Seite 267</p>	<p>zweifaches Kugellager - vernietet, Radachse verschraubt - gesichert, alle Teile aus Edelstahl rostfrei</p> <p>→ Seite</p>	<p>AUSWAHLHILFE:</p> <ul style="list-style-type: none"> leicht lenkend <input type="checkbox"/> <input checked="" type="checkbox"/> <input checked="" type="checkbox"/> verschleißarm <input type="checkbox"/> <input checked="" type="checkbox"/> <input checked="" type="checkbox"/> stoßfest <input type="checkbox"/> <input checked="" type="checkbox"/> <input checked="" type="checkbox"/> bodenschonend <input type="checkbox"/> <input checked="" type="checkbox"/> <input checked="" type="checkbox"/> witterungsbeständig <input checked="" type="checkbox"/> <input checked="" type="checkbox"/> <input checked="" type="checkbox"/>

Technische Details

ORDERNO (Artikel-nummer)	312X RÜ 50 EL
WDAB (Rad-Ø A x Breite B / mm)	50x18
LC (Tragkraft / kg)	40
H (Bauhöhe H / mm)	75
HD (Loch-Ø / mm)	10.2
SR (Schwenkradius / mm)	85
WB (Radlager)	Polyamid-Gleitlager