

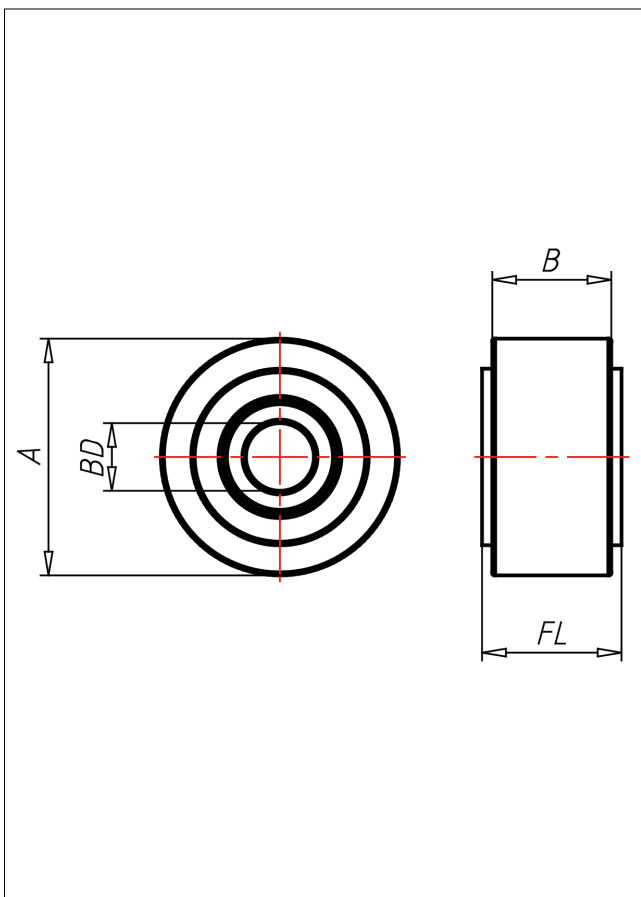

PAK Rad

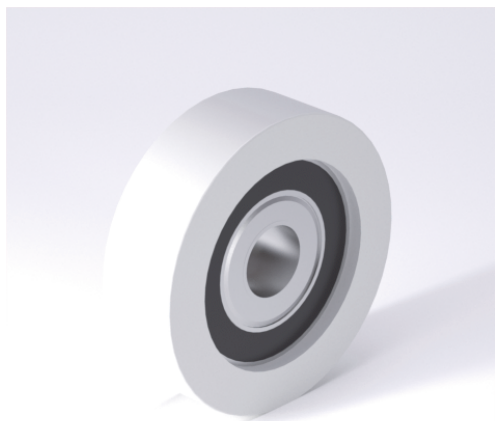

PAK



Rad aus Polyamid 6-1. Wahl
Kugellager umspritzt

High quality nylon wheel
Ball bearing extrusion molded

- leichter Lauf auf glatten Böden
- stoß- und schlagfest
- hohe Abriebfestigkeit
- leicht zu reinigen
- sehr beständig gegen viele aggressive Medien

- easy running on smooth floors
- impact proof
- high abrasion resistance
- easy to clean
- high chemical resistance

Technische Details

ORDERNO (Artikel-nummer)	50x18 PAK 12
WDAB (Rad-Ø A x Breite B / mm)	50x18
LC (Tragkraft / kg)	170
FL (Einbaulänge / mm)	10
WB (Radlager)	1 Rillen-Kugellager 6201-2RS
BD (Bohrungsdurchmesser / mm)	12