

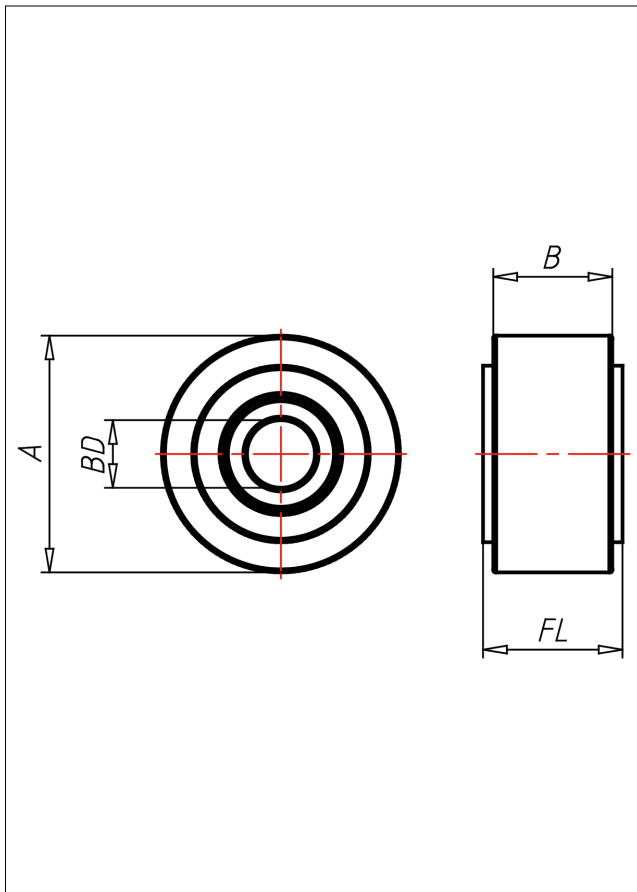

# PAK Rad

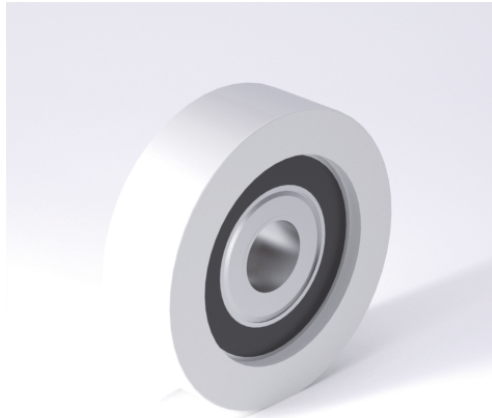

## PAK



Rad aus Polyamid 6-1. Wahl  
Kugellager umspritzt

High quality nylon wheel  
Ball bearing extrusion molded

- leichter Lauf auf glatten Böden
- stoß- und schlagfest
- hohe Abriebfestigkeit
- leicht zu reinigen
- sehr beständig gegen viele aggressive Medien

- easy running on smooth floors
- impact proof
- high abrasion resistance
- easy to clean
- high chemical resistance

### Technische Details

<b>ORDERNO (Artikel-nummer)</b>	50x20 PAK 12
<b>WDAB (Rad-Ø A x Breite B / mm)</b>	50x20
<b>LC (Tragkraft / kg)</b>	190
<b>FL (Einbaulänge / mm)</b>	10
<b>WB (Radlager)</b>	1 Rillen-Kugellager 6201-2RS
<b>BD (Bohrungsdurchmesser / mm)</b>	12