

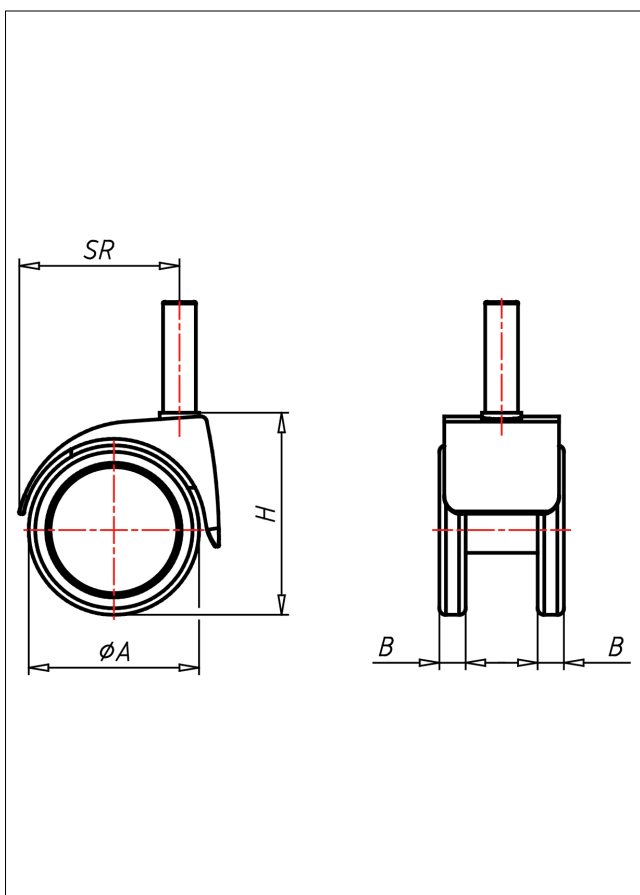

530 PU Lenkrolle

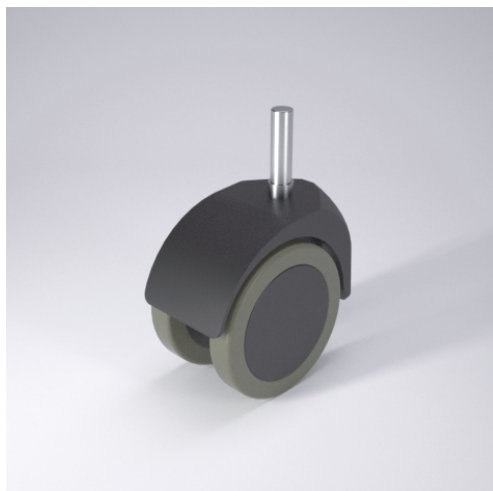

530-PU



+60 °C
-20 °C

max.
60 kg



schwarzes Gehäuse aus Polyamid 6
Schwenklager mit kombiniertem
Gleit-Kugellager
Felge Polyamid schwarz
elastischer PUR-Reifen - spurfrei
Radfeststeller glasfaserverstärkt
Radachse vernietet

Technische Details

ORDERNO (Artikel-nummer)	530 10x34 50 PU
WDAB (Rad-Ø A x Breite B / mm)	52x8+8
LC (Tragkraft / kg)	40
H (Bauhöhe H / mm)	62
BOLT (Stift / mm)	10x34
SR (Schwenkradius / mm)	46
WB (Radlager)	Polyamid-Gleitlager