

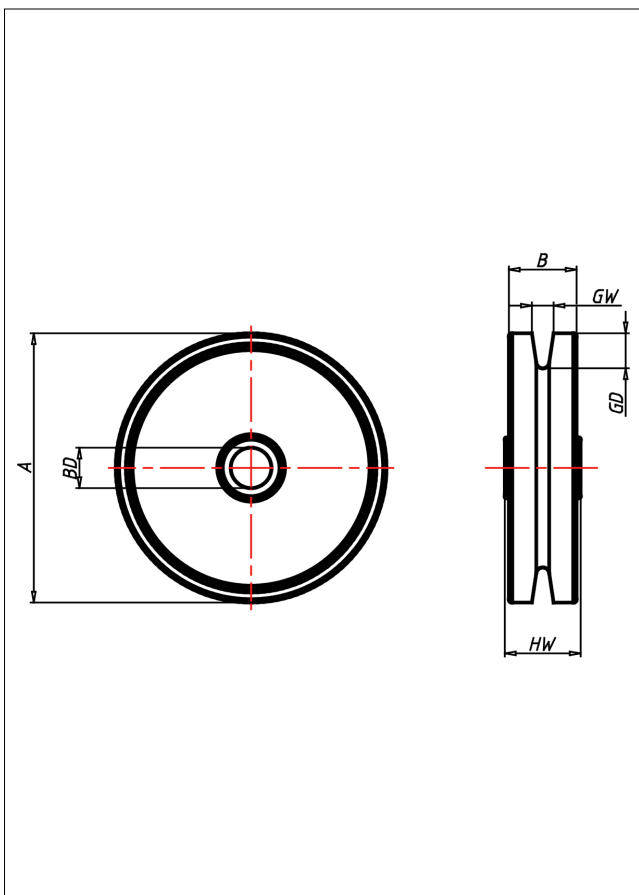

# Seilrollen aus Polyamid

## Seilrolle

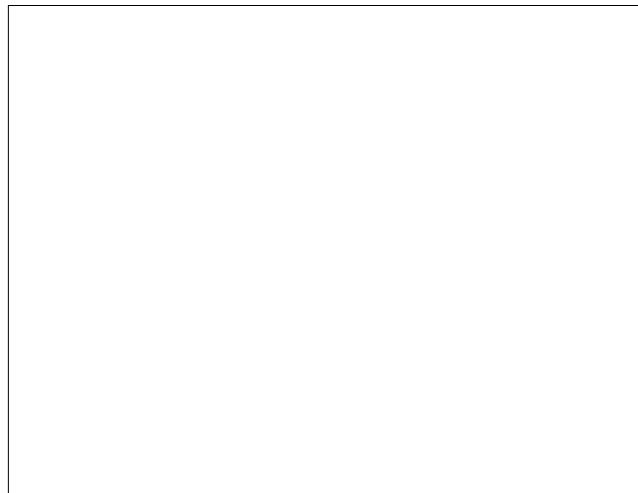

Seilrollen P6  
Seilrollen aus  
Polyamid



### Technische Details

ORDERNO (Artikel-nummer)	901/100
WDAB (Rad-Ø A x Breite B / mm)	100x13
LC (Tragkraft / kg)	85
GD (Nut-tiefe / mm)	10
GW (Nut-breite / mm)	2
HW (Nabellänge / mm)	17
FL (Einbaulänge / mm)	17
WB (Radlager)	Gleitlager
BD (Bohrungsdurchmesser / mm)	10