

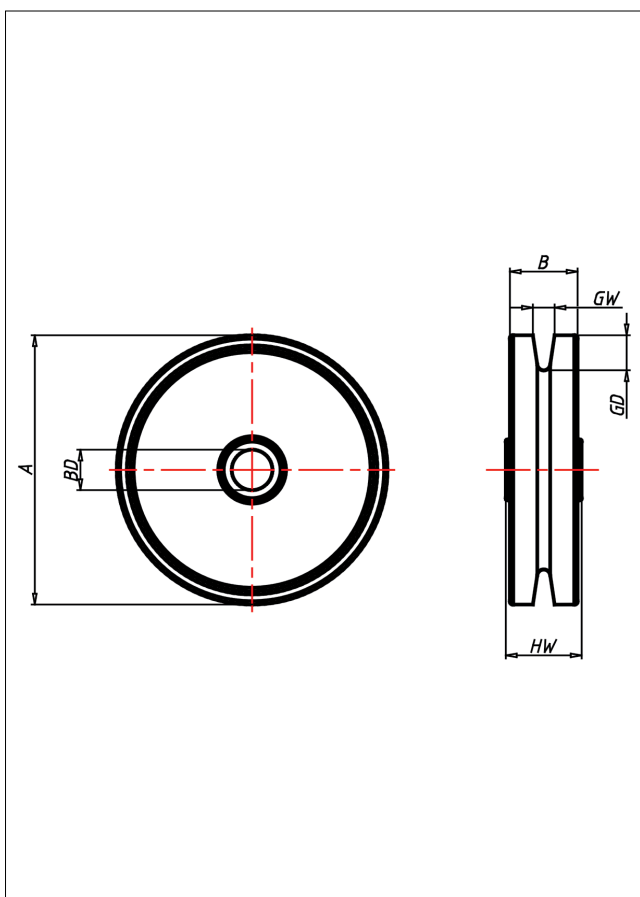

Seilrollen aus Polyamid

Seilrolle



Seilrollen P6
Seilrollen aus
Polyamid



Technische Details

ORDERNO (Artikel-nummer)	901/122
WDAB (Rad-Ø A x Breite B / mm)	120x22
LC (Tragkraft / kg)	240
GD (Nut-tiefe / mm)	15
GW (Nut-breite / mm)	6
HW (Nabellänge / mm)	28
FL (Einbaulänge / mm)	28
WB (Radlager)	Gleitlager
BD (Bohrungsdurchmesser / mm)	20