

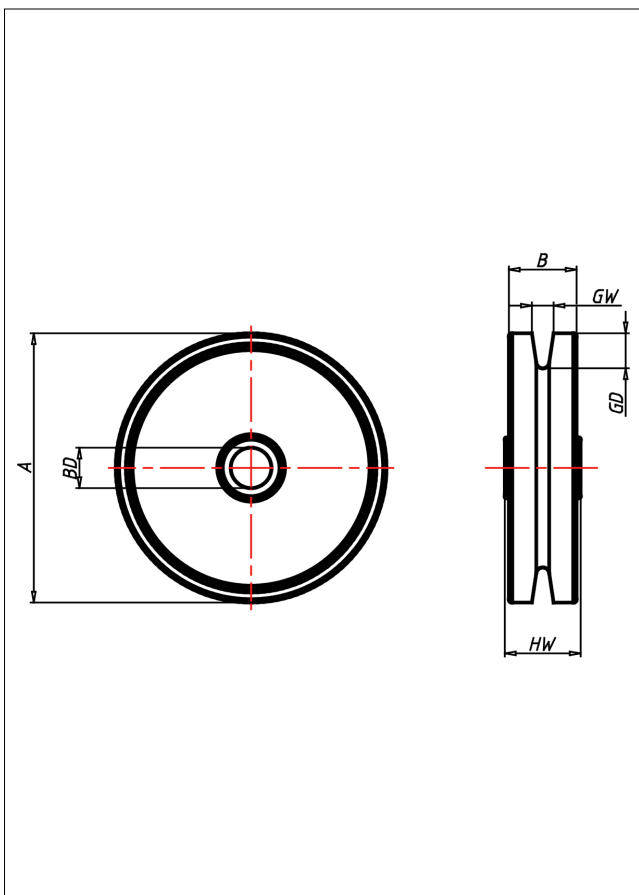

# Seilrollen aus Polyamid

## Seilrolle



Seilrollen P6  
Seilrollen aus  
Polyamid



### Technische Details

ORDERNO (Artikel-nummer)	901/40
WDAB (Rad-Ø A x Breite B / mm)	40x13
LC (Tragkraft / kg)	23
GD (Nut-tiefe / mm)	6
GW (Nut-breite / mm)	4.5
HW (Nabellänge / mm)	13
FL (Einbaulänge / mm)	13
WB (Radlager)	Gleitlager
BD (Bohrungsdurchmesser / mm)	7