

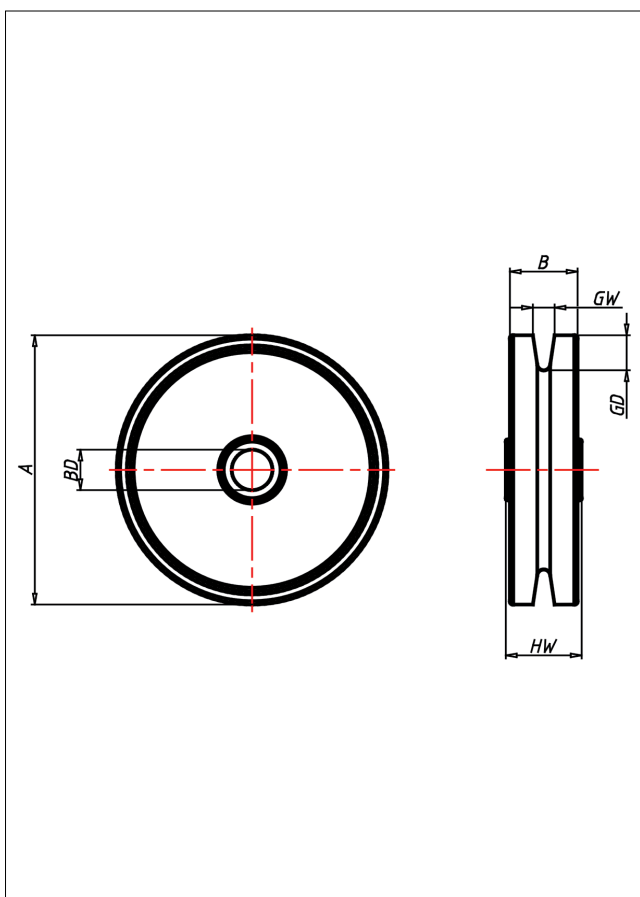

Seilrollen aus Polyamid

Seilrolle



Seilrollen P6
Seilrollen aus
Polyamid



Technische Details

ORDERNO (Artikel-nummer)	901/51
WDAB (Rad-Ø A x Breite B / mm)	50x10
LC (Tragkraft / kg)	30
GD (Nut-tiefe / mm)	5
GW (Nut-breite / mm)	2
HW (Nabellänge / mm)	11
FL (Einbaulänge / mm)	11
WB (Radlager)	Gleitlager
BD (Bohrungsdurchmesser / mm)	15