

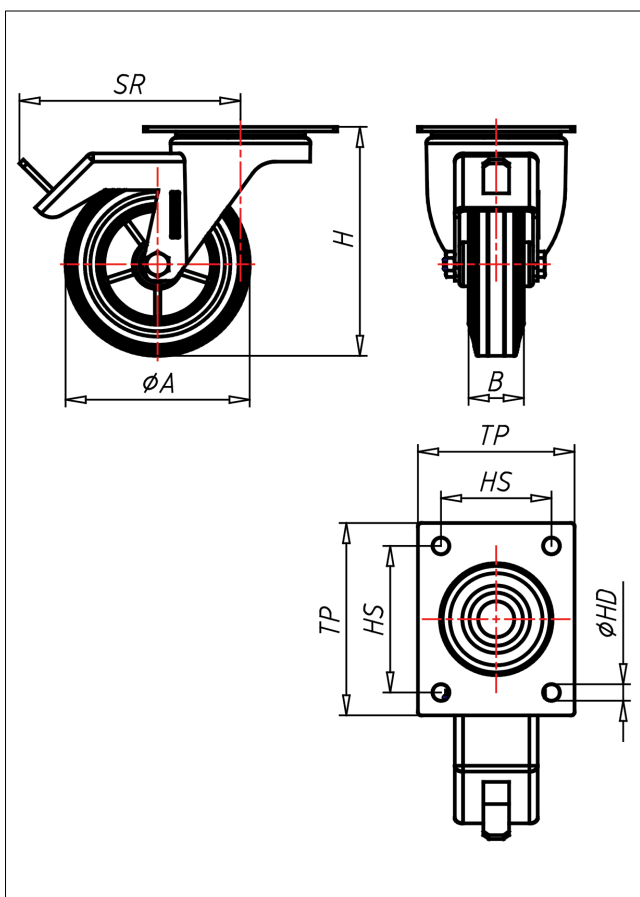

# INT/INVT-D

## Lenkrolle mit Totalfeststeller



IN-D



LENKROLLE	LENKROLLE MIT TOTALFESTSTELLER	BOCKROLLE																		
 <ul style="list-style-type: none"> <li>• geräuscharmer Lauf</li> <li>• großer Fahrkomfort</li> <li>• beständig gegen verdünnte Säuren</li> </ul> <p>Vollgummi schwarz Felge Kunststoff schwarz → Seite 265</p>	 <p>zweifaches Kugellager - verschraubt, Staubschützring, Radachse verschraubt - gesichert, Edelstahl poliert → Seite 110</p>	 <p>AUSWAHLHILFE:</p> <table border="0"> <tr> <td>-</td> <td>+</td> <td>++</td> </tr> <tr> <td>leicht lenkend</td> <td>X</td> <td></td> </tr> <tr> <td>verschleißarm</td> <td></td> <td>X</td> </tr> <tr> <td>stoßfest</td> <td></td> <td>X</td> </tr> <tr> <td>bodenschonend</td> <td></td> <td>X</td> </tr> <tr> <td>witterungsbeständig</td> <td>X</td> <td></td> </tr> </table>	-	+	++	leicht lenkend	X		verschleißarm		X	stoßfest		X	bodenschonend		X	witterungsbeständig	X	
-	+	++																		
leicht lenkend	X																			
verschleißarm		X																		
stoßfest		X																		
bodenschonend		X																		
witterungsbeständig	X																			

### Technische Details

ORDERNO (Artikel-nummer)	INT 80 D
WDAB (Rad-Ø A x Breite B / mm)	80x30
LC (Tragkraft / kg)	60
H (Bauhöhe H / mm)	100
TP (Plattengröße / mm)	105x85
HS (Lochabstand / mm)	80x60
HD (Loch-Ø / mm)	9
SR (Schwenkradius / mm)	115
WB (Radlager)	Polyamid-Gleitlager