

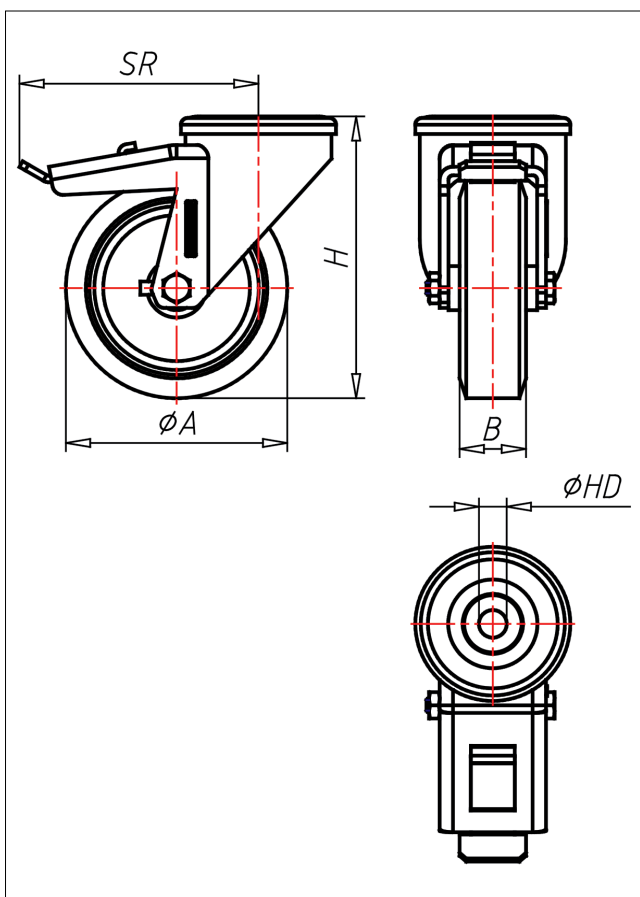

XRT/XRST-A/ABX

Lenkrolle mit Totalfeststeller



XR-A



LENKROLLE	LENKROLLE MIT TOTALFESTSTELLER																			
<ul style="list-style-type: none"> • geräuscharmer Lauf • geringer Rollwiderstand • abrieb- und reißfest • hohe Stoßfestigkeit • leichte Reinigung • sehr beständig gegen viele aggressive Medien <p>Guss-Polyurethan Felge Polyamid 6 → Seite 252</p>	<p>zweifaches Kugellager - vernietet, Staubschutzring, Edelstahl AISI 304 poliert, Laufkugeln AISI 420, Radachse verschraubt → Seite</p>	<p>AUSWAHLHILFE:</p> <table border="0"> <tr> <td>-</td> <td>+</td> <td>++</td> </tr> <tr> <td>leicht lenkend</td> <td>X</td> <td>X</td> </tr> <tr> <td>verschleißarm</td> <td>●</td> <td>X</td> </tr> <tr> <td>stoßfest</td> <td>●</td> <td>X</td> </tr> <tr> <td>bodenschonend</td> <td>●</td> <td>X</td> </tr> <tr> <td>witterungsbeständig</td> <td>●</td> <td>X</td> </tr> </table>	-	+	++	leicht lenkend	X	X	verschleißarm	●	X	stoßfest	●	X	bodenschonend	●	X	witterungsbeständig	●	X
-	+	++																		
leicht lenkend	X	X																		
verschleißarm	●	X																		
stoßfest	●	X																		
bodenschonend	●	X																		
witterungsbeständig	●	X																		

Technische Details

ORDERNO (Artikel-nummer)	XRT 80 A
WDAB (Rad-Ø A x Breite B / mm)	80x24
LC (Tragkraft / kg)	120
H (Bauhöhe H / mm)	106
HD (Loch-Ø / mm)	12.5
SR (Schwenkradius / mm)	108
WB (Radlager)	Polyamid-Gleitlager